



GENERAL CHARACTERISTICS

Curve detection by analysing the angular rate with electronics conform to railway standards. A micro mechanical spring-mass-system continuously measures the angular velocity and converts the measured value to two independent outputs (4-20 mA and 0-10 V). Angular rate sensor according to railway safety standards DIN EN 50155 and ready to use with the voltage supply directly from the trainset.

- Measurement range $\pm 12^\circ/s^*$
- Current output 4-20mA
- Voltage output 0-10V
- Offset compensation
- Resistant housing
- Protection class IP42, IP67 on request
- Compliant to DIN EN 50155
- Operating temperature $-40^\circ C \dots +85^\circ C$
- Wide supply voltage range
- Self-Test function

* customizable





TECHNICAL PARAMETERS

Physical parameters	
Rotation axis	1 (z-axis)
Measurement range	$\pm 12^\circ/s^*$
Sensitivity (current)	0.67 mA/ $^\circ/s$
Sensitivity (voltage)	416.7 mV/ $^\circ/s$
Sensitivity error	$\pm 2\%$
Noise	0,2% RMS of fullscale
Cutt off frequency (-3dB)	4 Hz
Current output	4 ... 20 mA
Zero signal	12 mA
Voltage output	0 ... 10 V
Zero signal	5 V
Temperature offset error (Delta T _{max} = 0.5K/min)	$\pm 3\%^{**}$
Maximum error	$\pm 5\%^{**}$
Output impedance (current)	max. 500 Ω
Charge voltage	max. 2500 Ω
Housing	Die-cast aluminum
Applied standard	DIN EN 50155
Operating temperature range	-40°C ... +85°C
Protection	IP42*

* Customizable

** Depends on the settings of the offset-compensation

Electrical parameters	Min.	Typ.	Max.	Unit
Supply voltage	70	110	160	V
	9	24	36	V
Supply current		0.02		A
Consumption		max. 3		W
Insulation		>200M		Ω

All specifications at +25°C, unless otherwise defined.



CURRENT AND VOLTAGE OUTPUT

Curve Detector			
Angular rate [°/s]	-12	0	+12
Output current [mA]	4	12	20
Output voltage [V]	0	5	10

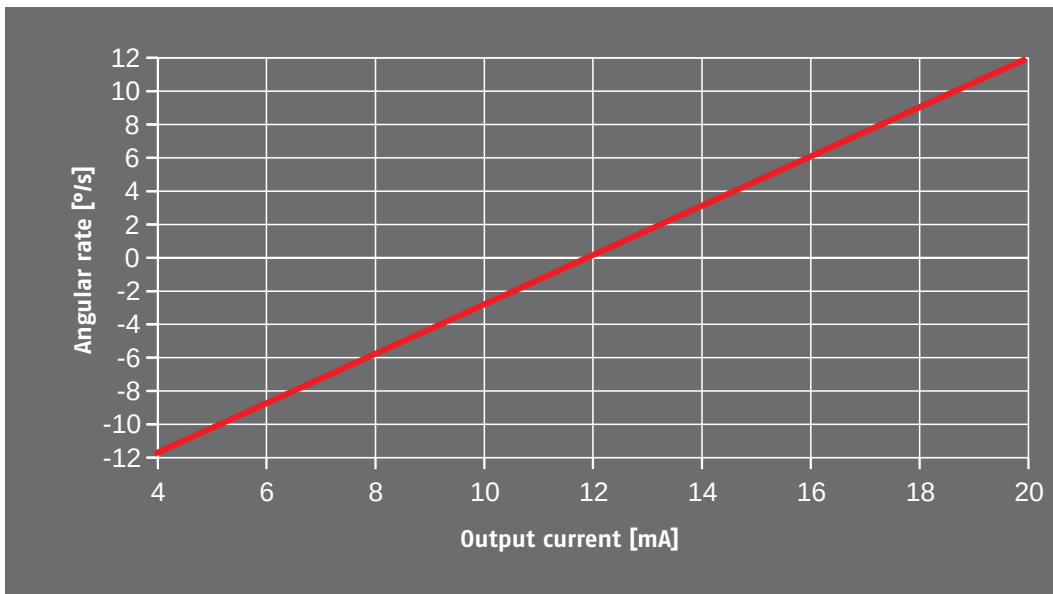

Figure 1: Output current

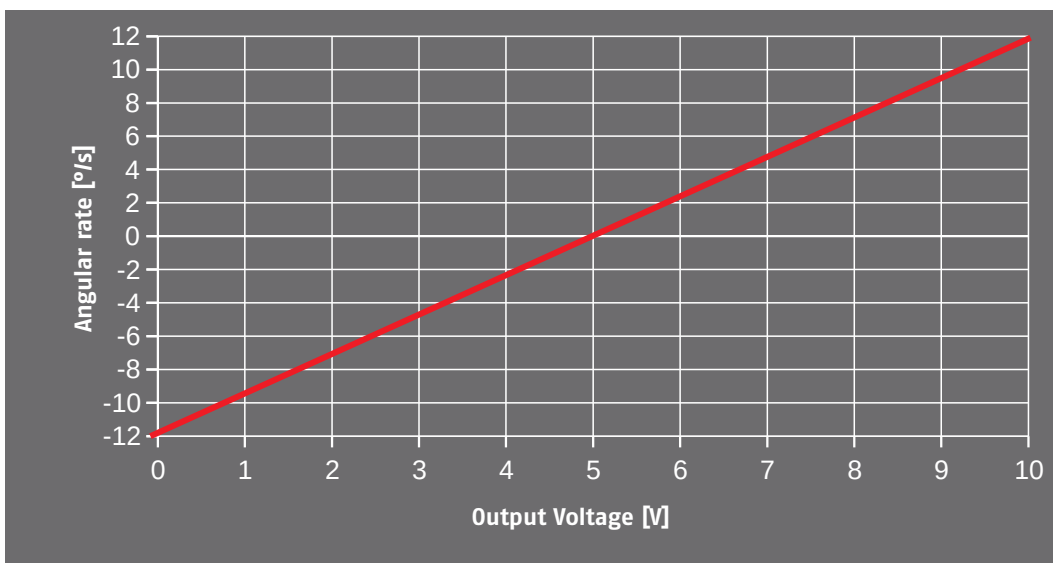

Figure 2: Output voltage



CURRENT OUTPUT CONNECTION

Load resistance: max. 500 Ω

Connect a resistor to the signal output and signal ground of the current output as shown in figure 3.

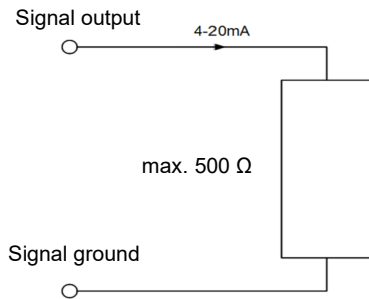

Figure 3: Current output connection

SHIELDING CONCEPT

Connect the housing to train earth potential.

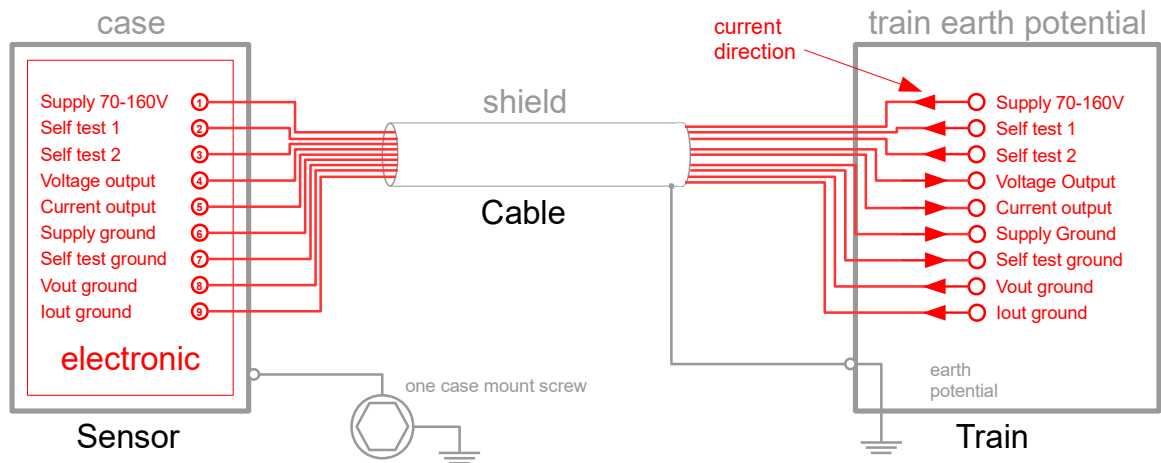

Figure 4: Shielding concept



CONNECTOR AND HOUSING

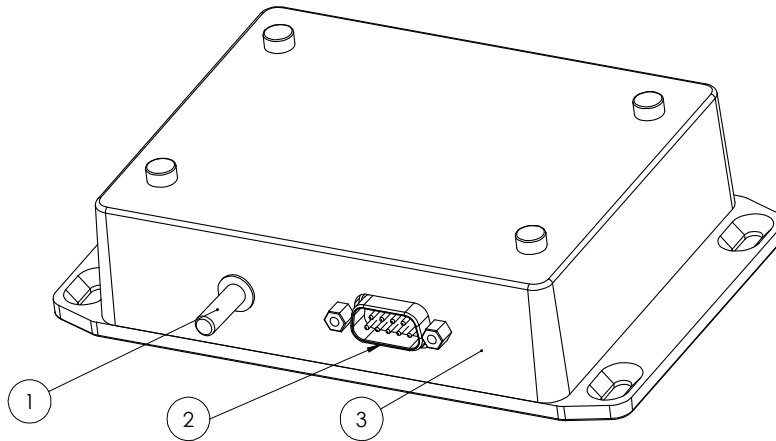

Figure 5: Curve Detector with D-Sub connector

No.	Component
1	M5 screw for grounding
2	D-Sub connector (CONEC No.15-000573)
3	Housing

PINOUT

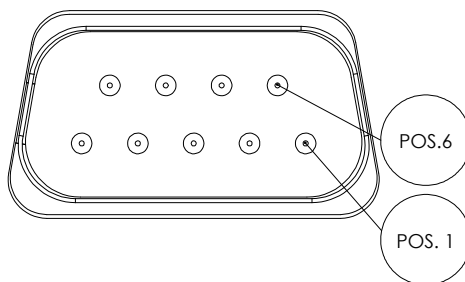

Figure 6: Pinout (front view)

Pin	Signal
1	Supply voltage
2	Self-Test 1
3	Self-Test 2
4	Voltage output
5	Current output
6	Supply ground
7	Self-test ground
8	Voltage output ground
9	Current output ground



SELF-TEST FUNCTION

The sensor includes a self-test (ST) feature. Self-test is activated by applying a logic high level to ST1 (pin2) or ST2 (pin3) related to self-test GND (pin7).

Applying logic high to pin ST1 sets the output to the end value of the right rotation. Applying logic high to pin ST2 sets the output to the end value of the left rotation (figure 8: Self-test function shown at voltage output).

The self-test function is available at the current and voltage output simultaneously.

It is recommended to use both test signals only in succession and both no longer than 2 seconds. Do not use the self-test during the power-on time in the first 20 seconds.

ST Input	
Low (V_{IL})	High (V_{IH})
0V	24V $\pm 10\%$

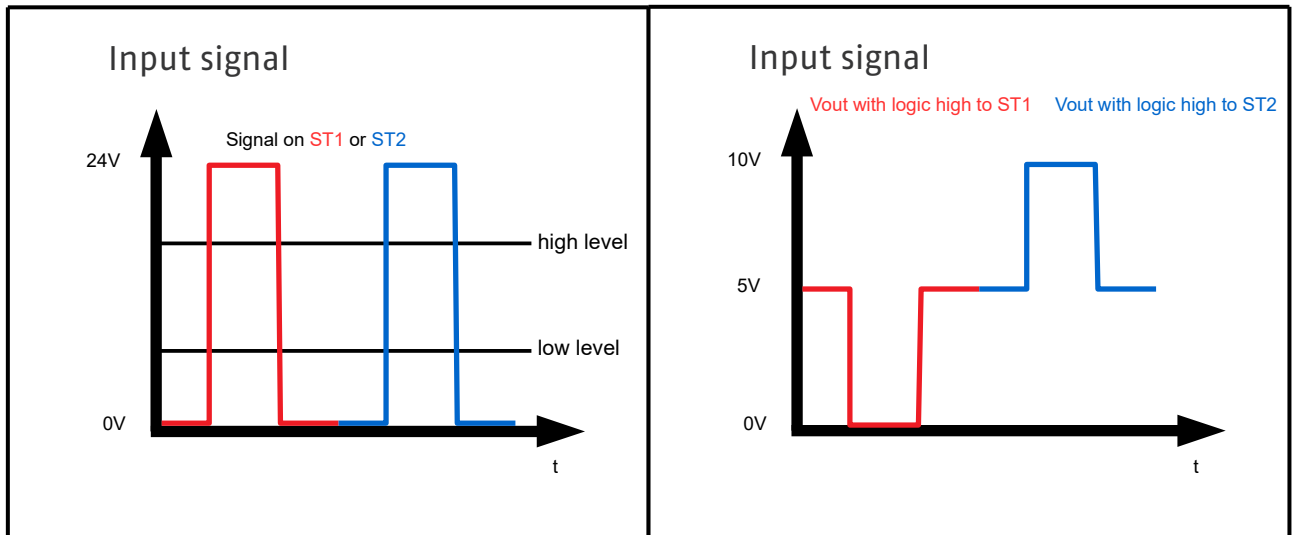

Figure 8: Self-test function at voltage output





RULES OF OPERATION

For a regular operation of the curve detector the following rules are mandatory:

- *Do not rotate the device in the first 20 seconds after power on.*
- *Do not use the Self-Test in the first 20 seconds after power on.*
- *The maximum duration of a rotation at maximum angular rate is 20 seconds.*
- *The ambient temperature must not change faster than 0.5K/min to assure an operation within the failure tolerances*

These rules can be adapted to meet customer requirements.

APPLIED STANDARDS

Applied standards according to DIN EN 50155	
DIN EN 55011	Conducted emission
DIN EN 55011	Radiated emission electromagnetic field
DIN EN 61000-4-3	Immunity to electromagnetic field
DIN EN 61000-4-4	Immunity to electrical fast transient/burst
DIN EN 61000-4-5	Immunity to electrical slow transient/surge
DIN EN 61000-4-6	Immunity to conducted RF voltage
DIN EN 50155	Overvoltage at power supplies
DIN EN 61373	Shock and vibration tests
IEC60068-2-1 (Bd)	Dry heat test
IEC60068-2-30 (Db)	Damp heat, cyclic (2 x 24h cycle)
IEC60068-2-1 (Ad)	Cold test
DIN EN 45545	Fire protection on railway vehicles



AVAILABLE STANDARD CONFIGURATIONS

Product Key:

CoriSENS ###V##

Supply voltage:

110: 110 VDC

24: 24 VDC

Measurement range

7: ± 7 °/s

12: ± 12 °/s

20: ± 20 °/s

Further options on request